



VISION GRILLS™

Patented

Quickchange™

# Professional Kamado Gas Insert

## WELCOME TO VERSATILE KAMADO COOKING

Your new Kamado Quickchange Gas Insert completes your existing Vision Grills Kamado, allowing you to sear, grill, bake, and smoke all types of food with your choice of Charcoal or Gas.

For those times you want to quickly prepare a meal without the use of charcoal, you have the Quickchange Gas Insert to help you. Simply pull out the removable Ash Drawer and slide in the Gas Insert, position the Heat Exchanger, and fire it up!

Welcome to the newest innovation for versatile Kamado cooking! Before beginning, make sure to read the following Manual completely for instructions on operating with **GAS**.



Patented

## PARTS

### PART NAMES

PART NAMES	PART NUMBERS
1 Lava Stone	VGK-VCR1
2 Stainless Steel Stone Bracket	VGK-BRACKET
3 Infrared Heat Exchanger	VGC-GPIHE
4 Gas Grill Burner Insert	VGC-GPBI-S
4.1 Gas Grill Burner Insert Knob	VGC-GPBIK
4.2 Ignition Button Cap	VGC-GPIBC
5 Gas Supply Line w/ Regulator	VGC-GPSLR
6 Gas Tank Caddy	VGC-GPTC-SS
6.1 Gas Tank Caddy Knob	VGC-GPTCK
6.2 Gas Tank Caddy Rubber Wheel	VGC-GPCWHL
7 Gas Supply Hose Bracket (x2)	VGC-GPGSLC-2
8 Match Ignition Tool	VGC-MIT

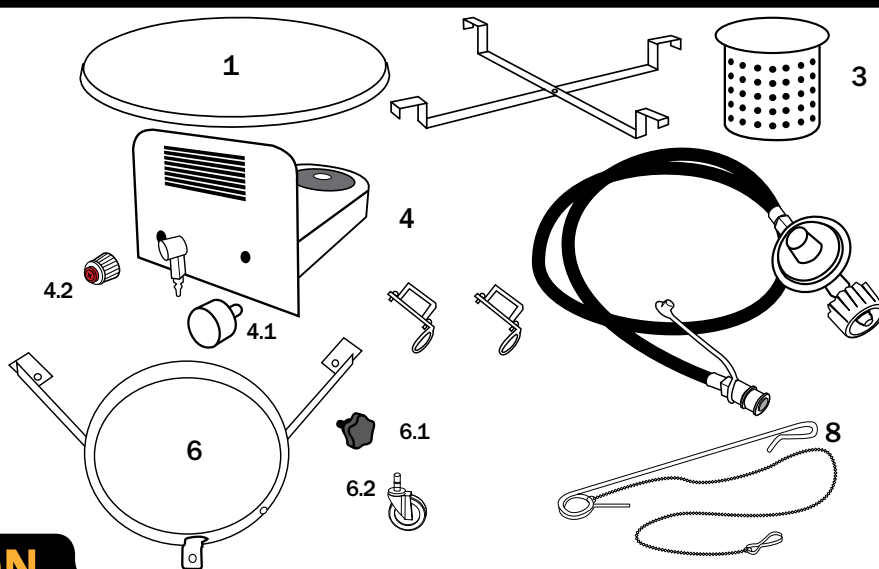

## SAFETY INFORMATION

PLEASE READ THE ENTIRE MANUAL BEFORE OPERATING YOUR VISION GRILLS KAMADO GRILL. PLEASE KEEP THIS MANUAL FOR FUTURE REFERENCE.

**ATTENTION!** Use caution when cooking as grill surfaces get hot. To avoid burns, always use protective gloves to adjust top and bottom vents when grill is in use. Do not wear loose clothing near the grill.

**ATTENTION!** This barbecue will become very hot; do not move it during operation. For outdoor cooking use only. Do not operate grill indoors or in an enclosed space. Use grill only in well ventilated area around the grill, free from combustible materials. Allow for at least 3 feet/1 meter of clearance around grill (house, other outdoor products, hanging tree limbs, shrubs, etc.).

**WARNING!** Keep children and pets away from the grill at all times. Do not allow children to operate grill. Never leave grill unattended when in use.

Grill needs to be placed securely on a level base prior to use. Only operate grill on a hard, stable level surface (concrete patio, ground, etc.) capable of supporting the grill's weight when loaded with food. Never operate grill on wood support surface, wood deck or similar combustible support surfaces under any conditions. Never attempt to move grill when it is in operation or cooling down. Never operate this grill within 25 feet/7.5 meters of any flammable liquid. Never operate this grill within 10 feet/3 meters of a gas cylinder. The grill should not be placed under combustible structures, such as garage, porch, patio, or carport. Burning charcoal or propane gives off carbon monoxide, which has no odor and can cause death.

The use of alcohol, prescription or non-prescription drugs may impair the operator's ability to properly assemble or safely operate the grill. Do not use on boats or recreational vehicles.

**CAUTION:** Never use lighter fluid, gasoline, or other volatiles to start your charcoal, as they are dangerous and leave a residual taste in your food. NEVER use Charcoal Briquettes that contain starting chemicals or additives. Use only firelighters complying to EN 1860-3. Use utmost care when adding charcoal to grill. Electric start-up is recommended. Dispose of cooled ashes by placing them in aluminum foil, soaking with water and discarding in a non-combustible container.

When operating with gas, top vent **MUST** be open at all times, see instructions.

If using for outdoor kitchen, table, or enclosure a lava stone or paving stone must be placed between bottom of grill and resting surface. Do NOT rest ceramic grill body on wooden surface.

# SET UP

## Step 1: Install Gas Caddy to Grill Cart

- Place the Gas Tank Caddy between the rear legs of the grill cart (Step 1a).
- Fasten mounting brackets to cart by removing nut and bolt from each bracket, separating the top bracket piece from Gas Tank Caddy frame.

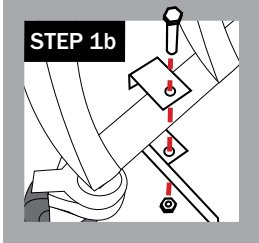
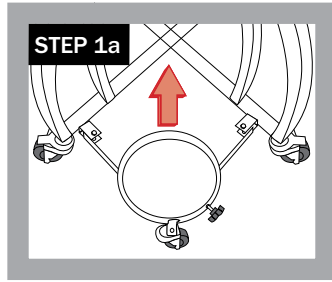

- Slide Gas Tank Caddy under Cart, so top bracket piece rests on cart frame and is lined up with bolt hole on bottom of Gas Tank Caddy.
- Reinsert bolt into frame and tighten together with nut (Step 1b).
- Use the provided wrench to tighten all connections.

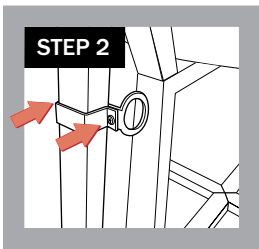

## Step 2: Attach Hose Brackets

- Attach the two hose brackets (used to hold gas hose), with eyelets facing in, onto the front and rear legs of cart (Step 2).
- Put the gas tank on the Gas Tank Caddy and tighten into place using Gas Tank Caddy knob (Step 3a).

Note: Do NOT allow the hose to touch the ceramic.

## Step 3: Install Gas Tank

- From rear of the grill, feed gas hose through eyelets of the hose brackets, grill connector first. Connect gas hose to the Gas Insert using the Quick Disconnect fitting.
- Make sure the cylinder valve is closed (turn valve clockwise until tight).
- Inspect valve connections, port, hose and regulator assembly for any damage or debris. Remove any debris.

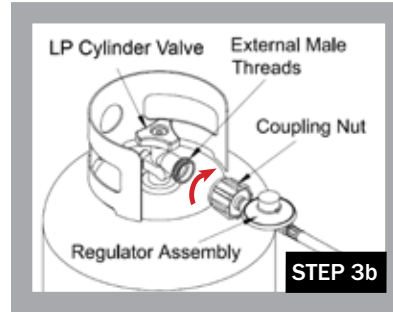
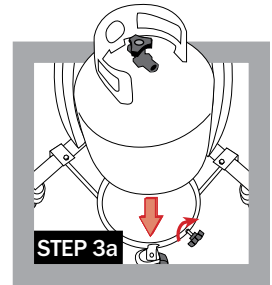

- When connecting regulator assembly to the valve, hand tighten the quick coupling nut clockwise to a complete stop (Step 3b).
- After the gas hose is connected to the gas tank and Gas Insert, open valve on gas tanks and perform some type of leak test\* method to test the connection.

## Step 4: Install Battery

- Remove Ignition Button Cap by turning counter clockwise. Insert AA battery (not included) negative end first.
- Replace Ignition Button Cap by tightening clockwise.
- Press Red Ignition Button and hold in to test battery. This will create spark on burner that will start your grill. (See STARTING SECTION for starting operation).

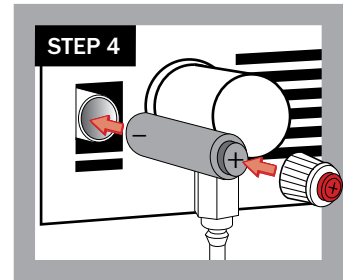

# WARNING

Always wait for grill to completely cool before opening built-in ash drawer.

When charcoal cooking above 500° F/260° C, with both top and bottom vents closed, rapidly opening the lid creates a sudden rush of oxygen into the grill, which can cause a flare-up of flames. When in this cooking mode, we recommend that, prior to opening the lid, you open both top and bottom vents to allow oxygen to stabilize inside the grill, minimizing the possibility of flare-ups.

**WARNING: To avoid shock, do not touch spark on burner.**

# MAINTENANCE & TROUBLESHOOTING

- After grill has cooled, use a soft cloth to clean exterior of grill.
- Clean the cooking grates before and after cooking.  
Note: Remove surface dust and grease.
- Infrared Heat-Exchanger should be clean prior to each use.
  - Check for debris in the heat exchanger.
  - If debris is present, please remove it with a stiff brush.
- Clean Side Shelves with mild detergent.
- When grill is cooled, use grill cover to prolong life of grill.
- When the Gas Insert is not in use:
  - Ensure that the Control Knob is off.
  - Ensure that the valve on gas tank is turned to Closed position.
  - Ensure that there is not gas leakage from the gas hose.
- Leak Detection Method.
  - Inspect valve connections, port and regulator assembly.
  - Look for any damage or debris. Remove debris.
  - Inspect hose for damage.
  - Turn gas cylinder knob clockwise to Open position.
  - Pour soapy water or Leak Test Solution (sold separately) at the connection spot of the gas cylinder to check whether there is gas leakage.
  - Make sure hose has good connection  
**NOTE: Check whether bubbles appear. (If there are no bubbles, there is no air leakage; If bubbles appear, there is gas leakage.)**
  - Repeat Leak Test at the connection spot at the gas entrance of the gas insert to check whether there is gas leakage.
  - If you cannot solve your problem by the above steps, please contact Vision Grills Customer Service at [help@visiongrills.com](mailto:help@visiongrills.com) or [www.visiongrills.com](http://www.visiongrills.com).
- If you are having trouble getting to "HIGH", review step "7" of "STARTING." Again, make sure to push in the Control Knob and turn all the way to the left, until the tick mark is horizontal. If encountering further issues, contact Customer Service.
- Make sure you are using Propane and NOT Natural Gas. This unit is not compatible with Natural Gas.
- If you are still having gas connection problems please disconnect and reconnect the hose to the propane tank and SLOWLY turn Tank Valve to OPEN. Sometimes turning the Tank Valve too fast triggers the built-in safety regulated connection.

### Watch For Bubbles



## Manual Ignition (Match Ignition) Method of Operation

- Put match in the ignition tool as shown.



- Light match, insert inside the front right opening as shown.



- Slide match to the inside back of the Gas Insert, reaching the burner. (Rear Side View shown)



- Turn the knob to Low and press it down until it is lit.  
*If ignition does not occur within 5 seconds, turn the Control Knob to OFF position. Wait 5 minutes and repeat the lighting procedure.*



- Light the gas and observe flame within the Heat Exchanger.



# STARTING

ATTENTION: The grill needs to be cooled before switching from the Ash Drawer to the Quickchange Gas Insert.

## Step 1: Fully Open Top Vent

Turn Top Vent to position 3 (or SEAR).

Keep the Top Vent fully open.

**WARNING: When using Quickchange Gas Insert, Top Vent must be open to position 3 (or SEAR) at all times.**

## Step 2: Remove Ash Drawer

Remove Cooking Grates and Charcoal Grate. Sweep all excess charcoal and ash into Ash Drawer. Pull out Ash Drawer and empty ash from drawer, then store in a cool, dry place.

## Step 3: Insert Gas Insert

Slide Gas Insert into grill opening in the base of the grill until it stops and locks into place.

## Step 4: Position Heat Exchanger

Install the stainless steel infrared Heat Exchanger on top of the Gas Insert. Allow the 2 bottom stems of Heat Exchanger to drop into the slots on top of the Gas Insert.



## Step 5: Place Heat Diffuser Lava Stone

Spread bracket so it makes an "X" shape and lower onto fire bowl, allowing the bracket to rest on edge of bowl. Lower Lava Stone onto the bracket. Replace cooking grates with hinged sections facing towards the front of grill.



## Step 6: Connect to Gas Tank

Using the Quick Connect fitting on the Gas Supply Hose, pull back spring-loaded locking ring and slide over male connection. Once it has snapped into place, give slight tug on gas line to ensure that it is securely connected. Turn the valve on gas tank to Open position SLOWLY.



## Step 7: Ignite Gas Insert

Use leak test\* to ensure there are no leaks. Open grill lid. Confirm the Control Knob is in the "OFF" position. Press and hold in the Red Ignition Button.

Device will emit a "clicking" sound. Push the control knob in and slowly turn from OFF setting to LOW setting. Continue to hold knob. While holding the control knob on the LOW setting press the Red Ignition Button. Continue to hold the knob on the LOW setting for about 5-6 seconds, to allow the thermocouple inside to get warm enough to maintain the flame. Observe fire is lit in Heat Exchanger. Close grill lid and observe grill thermometer. Adjust to desired temperature by adjusting Control Knob.



**NOTE: ALWAYS IGNITE YOUR INSERT IN THE LOW SETTING.** In order to get to "HIGH", push the Control Knob in and turn counter-clockwise until second "click" is heard and the tick mark is completely horizontal.

*If ignition does not occur within 5 seconds, turn the Control Knob to OFF position. Wait 5 minutes and repeat the lighting procedure.*

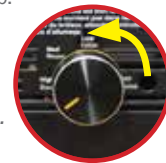

**\*Leak Test:** Pour Leak Test Solution (not included) or soapy water at the connection spot of the gas cylinder to check whether there is air leakage. If solution produces bubbles this means there is a leak.

### Watch For Bubbles



# SETTING TEMPERATURE

## Lock Top Vent

Turn Cast Iron Top Vent to position 3. Turn locking pin counter clockwise until it drops down in place, keeping the Top Vent fully open.

**WARNING: When using Quickchange Gas Insert, Top Vent must be locked open to position 3 at all times.**



The Quickchange cooking temperatures are controlled by adjusting the burner knob on the Gas Insert. Experiences may vary depending on your environment, temperature, wind flow, etc. We suggest grilling initially with the Kamado for 5-6 times to get past the learning curve of your grill, in your environment. The top vent plays a big role in regulating temperatures and putting out fuel. Your grill is properly seasoned when it has a buildup of creosote on the ceramic and top vent.

\*Caution - If you're cooking low and slow, do not let the grill get too hot. Keep the temperature low, it will take time to cool down.

\*Caution - Continuous grilling at high temperatures will cause the felt gasket to burn.

### PREVENT FLARE-UPS:

TO EXTEND THE LIFE OF THE FELT, MAKE SURE TO AVOID FLARE-UPS BY "BURPING YOUR GRILL".

If the lid is lifted too quickly, oxygen will rush inside the grill causing a flare-up. To prevent a flare up, lift the lid 1"/25mm and count to three before fully opening the grill. This method is called "Burping your Grill."

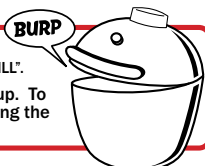

## SEARING

400°- 640°F  
200°- 340°C

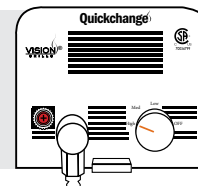

## GRILLING

300°- 400°F  
150°- 200°C

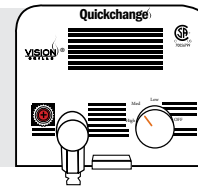

## SMOKING

175°- 225°F  
80°- 110°C

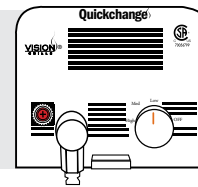

# COOKING TEMPERATURE

All cooking times and temperatures are approximate. Visit [www.foodsafety.gov](http://www.foodsafety.gov) for additional information on safe minimum cooking temperatures.

## SMOKING

	Approximate Cooking Time	Smoker Temp (°F)	Meat Temp. (°F)
<b>BEEF</b>			
Brisket (8 - 12 lbs)	1.5 hours/lb	225 - 250	185 - 205
Short Ribs	5 hours	225 - 250	Pulls back from bones
Tenderloin (3 - 4 lbs)	1-4 hours	225 - 250	120 - 160
<b>PORK</b>			
Baby Back Ribs (1.5 - 2.5 lbs)	5 hours	225 - 250	Pulls back from bones
Shoulder / Butt (6 - 8 lbs)	1.5 hours/lb	225 - 250	170 - 205
Ham (Bone In)	1.5 hours/lb	225 - 250	160
Spare Ribs (2.5 - 3 lbs)	5 - 7 hours	225 - 250	Pulls back from bones
Tenderloin (1.5 - 2 lbs)	2.5 - 3 hours	225 - 250	160
<b>POULTRY</b>			
Turkey (Whole)	15 - 20 min./lb	240 - 275	170
Chicken (Whole: 2.5 - 4.5 lbs)	2.5 - 4 hours	250 - 275	170

## GRILLING (350 - 450°F)

	Beef Temp (°F)	Pork Temp (°F)
Rare	125 + 3 min. Rest	—
Medium-Rare	130 - 135	145 + 3 min. Rest
Medium	135 - 140	150
Medium-Well	140 - 150	155
Well-Done	155+	160+
Ground	160	160
<b>Poultry Temp (°F)</b>		
Dark Meat	165 - 175	
White Meat	165	
Ground	170 - 175	

# GENERAL INSTRUCTIONS

This instruction manual contains important information necessary for the proper assembly and safe use of the appliance. Read and follow all warnings and instructions before assembling and using the appliance. Keep this manual for future reference.

Always wait for grill to be completely cooled before opening built-in ash drawer.

When charcoal cooking above 500° F/260° C, with both top and bottom vents closed, rapidly opening the lid creates a sudden rush of oxygen into the grill, which can cause a flare-up of flames. When in this cooking mode, we recommend that, prior to opening the lid, you open both top and bottom vents to allow oxygen to stabilize inside the grill before opening, minimizing the possibility of flare-ups.

- 1) The installation conforms with the National Fuel Gas Code, ANSI Z223.1/NFPA 54, Natural Gas and Propane Installation Code, CSA B149.1; or Propane Storage and Handling Code, B149.2.
- 2) This outdoor cooking gas appliance shall be used only outdoors and shall not be used in a building, garage or any other enclosed area.
- 3) This outdoor cooking gas appliance is not intended to be installed in or on boats and not intended to be installed in or on recreational vehicles.
- 4) Minimum clearance from sides and back of unit to combustible construction, 32" from sides and 32" from back. The outdoor cooking gas appliance shall not be used under overhead combustible surfaces.
- 5) Please inspect the hose before each use of the outdoor cooking gas appliance. If it is evident there is excessive abrasion or wear, or the hose is cut, it must be replaced prior to the outdoor cooking gas appliance being put into operation. The replacement hose assembly shall be that specified by the manufacturer.
- 6) Lighting Instructions
  - (a) Read the instructions before lighting.
  - (b) Open lid during lighting.
  - (c) Confirm that the control knob on the gas insert is on the "OFF" position.
  - (d) Open the gas tank valve knob.
  - (e) Press and hold in the Red ignitor button. Device will emit a clicking sound.
  - (f) While holding in the Red ignitor button, Push in the control knob and turn to "Low" position; a "click" will be heard, if operated correctly. Observe fire is lit.
  - (g) If ignition does not occur within 5 seconds, turn the burner control(s) off, wait 5 minutes, and repeat the lighting procedure.
- 7) Note
  - (a) Keep outdoor cooking gas appliance area clear and free from combustible materials, gasoline and other flammable vapors and liquids.
  - (b) Do not obstruct the flow of combustion and ventilation air.
  - (c) Keep the ventilation opening(s) of the cylinder enclosure free and clear from debris.
  - (d) Visually check burner flames including pilot burner flame.
- (e) Clean outdoor cooking gas appliance, including special surfaces, with recommended cleaning agents, if necessary.
- (f) Check and clean burner/venturi tubes for insects and insect nests. A clogged tube can lead to a fire beneath the grill.
- 8) If parts are missing, contact Vision Grills at (877) 917-4273 or contact Vision Grills via e-mail at [help@visiongrills.com](mailto:help@visiongrills.com) or through the website at [www.visiongrills.com](http://www.visiongrills.com).
- 9) The cylinder diameter is 12", the total height is 18" and volume is 20 lbs.
- 10) The LP gas supply cylinder(s) to be used must be constructed and marked:
  - (a) In accordance with the Specifications for LP-Gas Cylinders of the U.S. Department of Transportation (D.O.T.) or the National Standard of Canada, CAN/CSA-B339, Cylinders, Spheres and Tubes for Transportation of Dangerous Goods; and Commission, as applicable.
  - (b) Provided with a listed overfilling prevention device.
  - (c) Provided with a cylinder connection device compatible with the connection for outdoor cooking appliance.
- 11) If the outdoor cooking gas appliance is not in use, the gas must be turned off at the supply cylinder. Storage of an outdoor cooking gas appliance indoors is permissible only if the cylinder is disconnected and removed from the outdoor cooking gas appliance.

Cylinders must be stored outdoors out of the reach of children and must not be stored in a building, garage or any other enclosed area.
- 12) The pressure regulator and hose assembly supplied with the outdoor cooking gas appliance must be used. If pressure regulator and hose assembly are missing or need to be replaced, contact Vision Grills at (877)917-4273 or contact Vision Grills via e-mail at [help@visiongrills.com](mailto:help@visiongrills.com) or through the website at [www.visiongrills.com](http://www.visiongrills.com).
- 13) The cylinder used must include a collar to protect the cylinder valve.
- 14) (a) Do not store a spare LP-Gas cylinder under or near this appliance;  
(b) Never fill the cylinder beyond 80 percent full; and  
(c) If the information in "14-(a)" and "14-(b)" is not followed exactly, a fire causing death or serious injury may occur.
- 15) Place dust cap on cylinder valve outlet whenever the cylinder is not in use. Only install the type of dust cap on the cylinder valve outlet that is provided with the cylinder valve. Other types of caps or plugs may result in leakage of propane.
- 16) Instructions, including illustrations, on the proper cylinder orientation to provide vapor withdrawal.

## ▲ DANGER

If you smell gas:

- Shut off gas to the appliance.
- Extinguish any open flame.
- Open lid.
- If odor continues, keep away from the appliance and immediately call your fire department.

## ▲ WARNING

- Do not store or use gasoline or other flammable liquids or vapors in the vicinity of this or any other appliance.
- Any LP cylinder not connected for use shall not be stored in the vicinity of this or any other appliance.

# WARRANTY

Subject to the following terms and conditions, Phase 2, LLC, d/b/a Vision Grills ("Vision Grills") warrants to the original purchaser that the grill insert manufactured or supplied by Vision Grills will be free from defects in material and workmanship under normal use for the following periods from the original date of purchase: Five years for burner and all other metal parts; 90 days for lava stone & bracket, quick disconnect, hose and regulator. This Warranty is contingent upon purchaser registering the product at [www.visiongrills.com/register](http://www.visiongrills.com/register) or within 30 days from the date of purchase along with a copy of the original dated sales receipt which can be attached in an electronic format (i.e. scan, photograph, etc.) to your registration at [www.visiongrills.com/register](http://www.visiongrills.com/register). Failure to do so will invalidate the warranty. Any damages or defects present at the time of purchase must be noted on the original dated sales receipt. This Warranty is not transferable to subsequent owners. If you cannot register online, it will be necessary to contact Vision Grills customer service at (877) 917-4273 or email [help@visiongrills.com](mailto:help@visiongrills.com).

If any product covered by this Warranty is defective due to a covered warranty condition, such product will, at the option of Vision Grills, be repaired to its original condition or replaced with a comparable new product or part. The repair and/or replacement of parts shall constitute the extent of the liability and obligations of Vision Grills under this Warranty. Purchaser is required to provide photographic evidence to assess the damage when submitting claim.

This Warranty does not cover damages caused by improper assembly, improper care, failure to follow directions of use, misuse, abuse, negligence, extreme environmental conditions, normal wear and tear, accidents, acts of nature, or unauthorized repair, alteration or modification, as determined by Vision Grills. Vision Grills is not liable for any default or delay in its performance under this Warranty that is caused by any circumstances beyond its control. While Vision Grills uses rust-resistant materials, the Warranty as to metal parts does not cover rust or oxidation unless the structural integrity of the grill insert is compromised as determined by Vision Grills.

This Warranty does not cover purchases with unauthorized resellers and/or third parties. Warranty coverage is limited to products purchased at an authorized reseller only.

Commercial use and related applications are not covered under this Warranty. Warranty coverage is based on normal residential use and maintenance.

Vision Grills shall not be liable for any delay or default under this Warranty caused by any event or contingency beyond Vision Grills's control. This includes acts of nature, fire, government restrictions or restraints, strikes, reduced supply of materials or transportation delays.

THIS WARRANTY IS THE EXCLUSIVE WARRANTY OF VISION GRILLS. VISION GRILLS EXPRESSLY DISCLAIMS ANY AND ALL OTHER WARRANTIES, EXPRESS OR IMPLIED, INCLUDING WARRANTIES OF FITNESS, MERCHANTABILITY, OR FITNESS FOR A PARTICULAR PURPOSE. THIS WARRANTY DOES NOT COVER, AND VISION GRILLS IS NOT LIABLE FOR, ANY DAMAGES RELATING TO LOSS OF TIME, LOSS OF USE OF EQUIPMENT, INCONVENIENCE, OR ANY INCIDENTAL, SPECIAL AND/OR CONSEQUENTIAL DAMAGES. PURCHASER'S EXCLUSIVE REMEDY FOR BREACH OF THIS WARRANTY SHALL BE LIMITED AS SPECIFIED HEREIN TO REPLACEMENT OR REPAIR OF THE AFFECTED PRODUCT.

Some states do not allow limitations on how long an implied warranty lasts or the exclusion or limitation of incidental or consequential damages, so the above limitations and exclusions may not apply to you. This Warranty gives you specific legal rights, and you may also have other rights which vary from state to state. Vision Grills does not authorize any person or entity to assume any obligation or liability on its behalf in connection with the sale and purchase of any of its products. The purchase of any Vision Grills product from anyone other than Vision Grills or an authorized dealer will void the Warranty associated with the product. If you have a question regarding the identity of an authorized dealer, you should contact Vision Grills before you purchase the product.

To submit a warranty claim, the original purchaser or authorized agent of the original purchaser must contact Vision Grills at (877) 917-4273 or contact Vision Grills via e-mail at [help@visiongrills.com](mailto:help@visiongrills.com) or through the website at [www.visiongrills.com](http://www.visiongrills.com).



**WARNING: FUELS USED IN LIQUEFIED PROPANE GAS APPLIANCES, AND THE PRODUCTS OF COMBUSTION OF SUCH FUELS, CAN EXPOSE YOU TO CHEMICALS INCLUDING BENZENE, WHICH IS KNOWN TO THE STATE OF CALIFORNIA TO CAUSE CANCER AND CAUSE BIRTH DEFECTS OR OTHER REPRODUCTIVE HARM. For more information go to: [www.P65Warnings.ca.gov](http://www.P65Warnings.ca.gov).**

**ADVERTENCIA: LOS COMBUSTIBLES USADOS EN EQUIPOS PARA LICUAR GAS PROPANO, ASI COMO LOS PRODUCTOS DE SU COMBUSTION, PUEDEN EXPONERTE A SUSTANCIAS QUIMICAS, ENTRE ELAS EL BENCENO, QUE EL ESTADO DE CALIFORNIA RECONOCE COMO CAUSA DE CANCER Y DE MALFORMACIONES CONGENITAS Y OTROS DAÑOS AL SISTEMA REPRODUCTOR. Para más información, visite [www.P65Warnings.ca.gov](http://www.P65Warnings.ca.gov)**

[www.visiongrills.com](http://www.visiongrills.com) [help@visiongrills.com](mailto:help@visiongrills.com)

1-877-917-4273

Vision Grills 1531 Fairview Avenue, Suite B, St. Louis, MO 63132